

dBDI-2 User Manual



www.apex-audio.eu



APEX NV

Schoebroekstraat 62
3583 Beringen (Paal)
BELGIUM

Tel: + 32 (0)11 28 61 91
Fax: + 32 (0)11 25 56 38
e-mail: info@apex-audio.eu
website: www.apex-audio.eu

Trademarks

The APEX trademark is owned by APEX N.V. All other brand, product and company names and any other registered names or trade marks mentioned in this manual belong to their respective owners.

Disclaimer

APEX N.V. has taken all possible steps to ensure that the information given here is both correct and complete. In no event can APEX accept any liability or responsibility for any loss or damage to the owner of the equipment, any third party, or any equipment which may result from use of this manual or the equipment which it describes.

The information provided in this document may be modified at any time without prior warning. Specifications and appearance may differ from those listed and illustrated. Any complaint against APEX N.V. shall be governed by the laws of Belgium.

dBDI-2

Dual active Direct Injection box

November 2009

Serial number of this product:

© 2009 APEX N.V. All rights reserved.

This manual may not be reproduced or transmitted, either in part or as a whole, by any means, be they mechanical or electronic, without the express written permission of APEX N.V.

Intended use

The equipment may only be used for the purpose described in the operation instructions. Never carry out any work on the equipment other than as specified in the operating manual.

Environmental precaution



Electrical and electronic equipment may contain hazardous substances for humans and their environment.

The “crossed out wheellie bin” symbol present on the device and represented above is there to remind one of the obligation of selective collection of waste. This label is applied to various products to indicate that the product is not to be thrown away as unsorted municipal waste.

At the end of life, dispose of this product by returning it to the point of sale or to your local municipal collection point for recycling of electric and electronic devices.

Customer participation is important to minimize the

potential affects on the environment and human health that can result from hazardous substances that may be contained in this product.

Please dispose of this product and its packaging in accordance with local and national disposal regulations, including those governing the recovery and recycling of waste electrical and electronic equipment. Contact your local waste administration, waste collection company or dealer.

Register your product

Please take the time to register your product on-line by typing the following URL in your browser:

<http://productregistration.apex-audio.eu/>

As well as registering the product on-line, please take the trouble to record the serial number of the unit in the space provided on page 3 of the manual, and keep the manual in a safe place.

Product highlights

- Two independent channels, ideal for use with stereo keyboards, DJ consoles, etc.
- Low noise and distortion audio design with excellent headroom
- Low inter-channel crosstalk
- High quality output transformers; providing excellent output balance and true galvanic isolation
- Very low output impedance allows use of long cable runs
- XLR, ¼" jack and phone (RCA) inputs
- Ground lift switch per channel
- 3-position pad switch per channel permits matching of all signal levels
- Mono mix mode - channels are summed, mix feeds both outputs
- Can be powered from mixing console (via phantom power) or optional external AC adapter
- Speaker interface allows amplifier "sound" to be retained
- Power LED per channel
- Rugged all-metal chassis
- Professional quality connectors
- Optional rack kit available - mounts two units in 19" rack
- Kensington security lock

Thank you for buying the Apex dBDI-2.

The dBDI-2 is a professional quality, two channel, active direct injection (DI) box, which provides a simple method of connecting analogue audio signals of all types to professional amplification or recording systems.

The dBDI-2 has a number of unique features which distinguish it from other active DI boxes; even if you are familiar with this type of equipment, you are recommended to read this manual carefully to obtain the maximum benefit from the dBDI-2.

Overview

The Apex dBDI-2 can be used in any live performance or recording situation where you need to interface electric or electronic musical instruments, or “consumer” audio equipment with professional or broadcast equipment.

Examples of electric or electronic musical equipment are electric guitars, synthesisers, samplers and electronic keyboards of all types. Consumer audio equipment might include domestic CD & DVD players, computer sound cards, MP3 players and DJ consoles. By “professional or broadcast equipment” we mean touring or fixed venue PA systems, recording studio mixing consoles, TV or radio OB trucks, and so on.

Using the dBDI-2 gives you two main advantages:

- Most of the audio sources mentioned above are low-level, high-impedance or unbalanced, and often all three! These make them unsuitable for direct connection to professional equipment. Putting a dBDI-2 box in circuit means that they are correctly matched to the balanced inputs such equipment invariably has.
- The dBDI-2 additionally provides complete electrical isolation between the audio sources and the professional equipment, thereby removing at a stroke all the usual causes of hums and buzzes when different audio systems are interconnected.

In addition, the dBDI-2's dual-channel architecture and its unique sum mode switch opens up further applications, such as acting as a splitter. This would allow a sound source to be sent to two separate audio systems – such as FOH and monitor desks, or PA system and recording truck – with full signal isolation between all three connected systems.

Block diagram

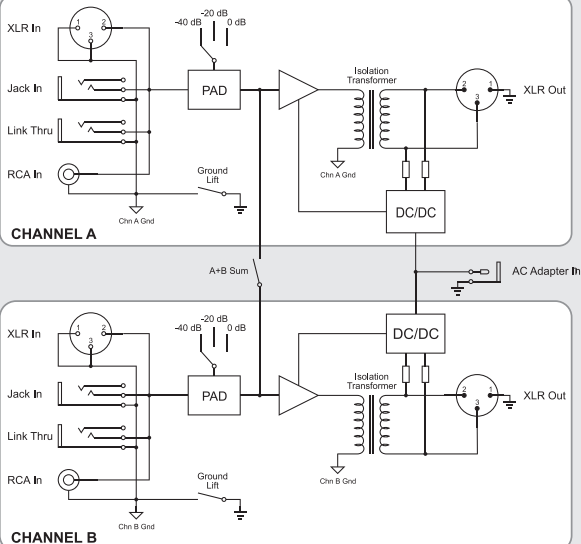

The diagram on the left shows a simplified block diagram of the dBDI-2.

The signal path is identical for the two channels.

Front and rear panel description

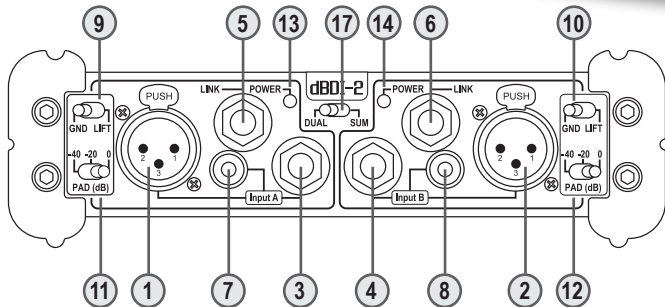

FRONT PANEL

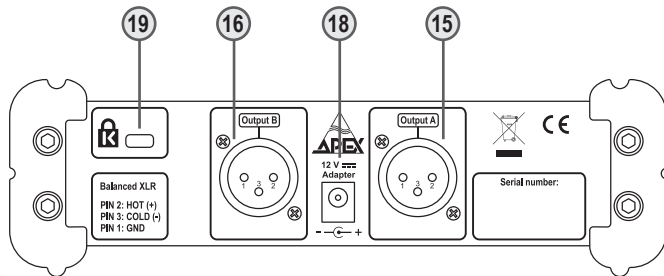

REAR PANEL

ITEM	CHANNEL A	CHANNEL B
Unbalanced inputs (XLR)	1	2
Unbalanced inputs (1/4" mono jack)	3	4
Unbalanced input link connector (1/4" mono jack)	5	6
Unbalanced input (phono)	7	8
Ground lift switch	9	10
Input pad switch	11	12
Power LED	13	14
Balanced outputs (XLR)	15	16
Dual/Sum mode switch	17	
Ext. DC power input	18	
Kensington® security lock	19	

Power requirements

This dBDI-2 can operate either from phantom 48V power supplied by a mixing console (or other equipment) connected to the unit's output, or an external AC mains adapter rated at 12 V DC.

Each channel has completely independent internal power circuitry and draws phantom power from its respective output connector.

Optional universal AC adapter

A universal, useable worldwide, AC adapter delivering 12 Vdc may be ordered separately from the dBDI-2.

Order code: APX-0ADAPTER-12V

No damage will result to the unit if both phantom power and an external DC supply are connected simultaneously.

Choice of inputs

The three inputs – XLR3F, ¼" jack and phono (RCA) – are all in parallel and any one may be used, depending on connector convenience. Do not connect audio sources to more than one (per channel) simultaneously. The inputs are all unbalanced and have the same impedance and sensitivity. Note that pins 1 and 3 of the XLR are shorted, and thus a balanced signal connected to it will become unbalanced.

LINK connector

The ¼" LINK connector is in parallel with all three inputs. It lets you use your existing instrument amplification (e.g., a guitar amp) while sending the instrument signal to the mixing console (or other equipment) that the dBDI-2's output is feeding. You can either insert the dBDI-2 between your instrument and the amp's input, or, if your amp top and speaker cabinet are separate, between the amp's output and the speaker. Examples are given in the "Applications" section.

Output

The output of each channel is on an XLR3M connector; the output is balanced and isolated by a transformer, providing a very low source impedance. This makes the dBDI-2 suitable for driving very long cable runs without significant signal loss. Another advantage of the transformer is that it provides full electrical isolation between the equipment connected to the DI box's inputs and the console or recording device at the output. This minimises the likelihood of hums and buzzes.

Always use XLR-XLR cables (usually referred to as "mic cables") with all 3 pins connected at both ends.

Pad Switch



The Pad switch lets you set the unit's input sensitivity to suit the various signal levels that different items of audio equipment can produce.

The highest sensitivity – i.e., that suitable for low-level sources such as some types of instrument pickups – is obtained with the switch in the **0dB** position. Sources such as "consumer" CD players and laptops are more likely to require a setting of **-20dB**. When using high-level sources such as guitar amplifier outputs, always set the Pad switch to **-40dB**.

If in doubt about the output level of the equipment you are connecting to the dBDI-2's input, always set the switch to **-40dB** initially, and check whether the signal being received at the mixing console (or other equipment) is sufficient; if not, increase the sensitivity by setting the pad to **-20dB**, and check again. The switch should be set so that no clipping is evident at the mixing console (or other equipment) on signal peaks.

Ground Lift switch



Hum loops can occur in interconnected audio equipment when different grounding (earthing) practices are employed; equipment or systems which operate cleanly in isolation generate a system-wide hum when connected together.

The problem can usually be resolved by separating the “screen” connection of the DI box’s input signal and the screen (pin 1) of the output XLR. This is the purpose of the Ground Lift switch. Set Ground Lift to **GND** by default, only “lift” the ground to resolve a hum problem.

Dual/Sum switch



With the Dual/Sum switch set to **Dual**, the dBDI-2’s two channels function independently, as if you were using two completely separate DI boxes. This is ideal for stereo sources, such as most keyboards, samplers, DJ consoles, etc.

Setting the switch to **Sum** connects the two channels together internally.

This lets you use the DI box in several extra ways:

- You can use the dBDI-2 as a signal splitter, whereby the input signal is sent to two completely separate destinations, with full isolation between everything. You’re limited to a mono input, though.
- If you’re running out of channels on the FOH mixer, you can use the dBDI-2 to mix two mono signals together to a single output.
- If you’re using two keyboards, you can use two dBDI-2s to reduce your stage feed to just one stereo pair. The FOH engineer will love you !

Important

When the Dual/Sum switch is set to **Sum**, it is important to ensure that the position of the ground lift switches on both channels is identical. This ensures a common ground potential between the channels, resulting in improved performance.

Stacking several dBDI-2's

Multiple dBDI-2s may be stacked vertically to save space on stage. The rubber side cheeks are specially designed to facilitate this, with the protrusions forming the “feet” slotting into the grooves on the top of the cheek of another unit, as shown. Several units may be stacked in this way, forming a stable assembly.

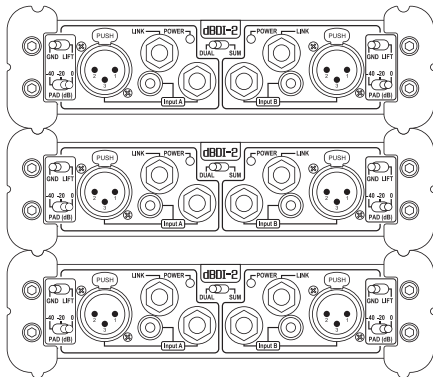

Security Lock



The rear of the dBDI-2 unit is equipped with a standard Kensington® computer-style security lock anchor point. This can be used with a Kensington® MicroSaver Security cable (available from most computer suppliers) to secure the DI box to a convenient immovable object. If units are rack-mounted, the cable anchor point can be a point within the racks internal structure, which will prevent the units from being removed even if the rack mount assembly is removed from the rack.

Optional Rack Mount Panel

Individual dBDI-2 units are intended to be used free-standing, however two dBDI-2 units may be mounted side-by-side in the optional 19" rack mount adapter .

The rack adapter is a standard 19" 1U panel with apertures for two dBDI-2 units, and four XLR3M connectors (two per unit) already fitted. The XLRs come with flying leads terminated in XLR3M connectors. Once installed in a rack, the DI box rear panel output connectors will no longer be accessible, so the connector/cable assembly re-situates them on the rack panel.

Fitting the dBDI-2's in the rack adaptor

1. Remove the two rubber side cheeks from one of the dBDI-2s. This is done by undoing the four M4 hex socket screws securing the cheeks to the front panel and the four similar screws securing them to the rear panel (screws are visible within the cheek rubbers). Retain the screws.

2. Fit the front panel of the DI box into the one of apertures in the rack panel (make sure it's the right way up!). Use four of the eight screws removed in Step 1 to attach the unit to the panel, inserting the screws through the four holes in the panel. Fit the four remaining screws removed in Step 1 to the rear of the unit.

3. Repeat Steps 1 & 2 for the second DI box.

4. Plug the four flying XLR cables into the four DI box outputs on the rear of the boxes. Take care not to cross any leads.

5. If external PSUs are being used, plug them in as well. Cable ties attaching the DC power leads to one or more of the flying output cables may be helpful in providing some additional strain relief.

6. The rack panel is now ready to mount in a rack, flight case or other housing. (See illustration on next page.)

TOP

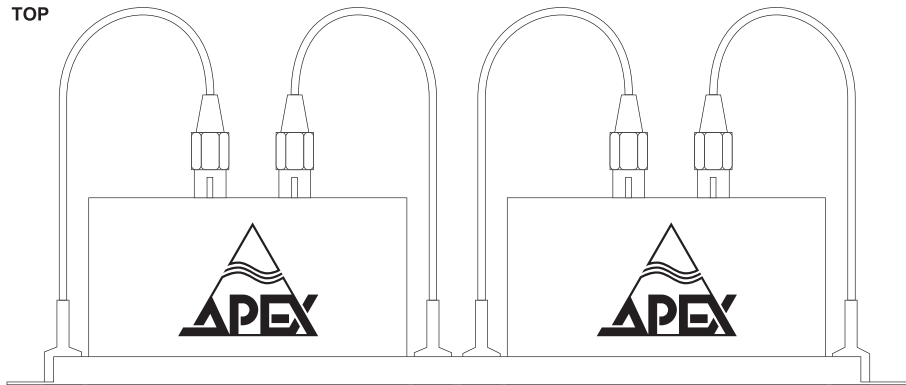

FRONT

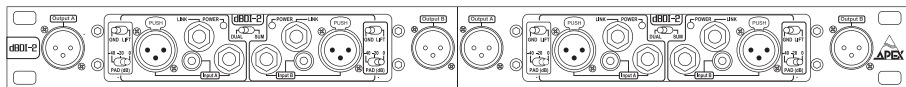

The following pages illustrate some typical applications for the dBDI-2:

1 *Obtaining a recording or FOH feed from an electric guitar*

Plug the guitar into Channel A's ¼" jack socket with a standard guitar lead. If using FX pedals, take the output from the last pedal instead if you want the effects to be sent to the mixing console as well. Use another to connect Channel A's LINK connector to the usual input of your guitar amplifier. Connect the output of Channel A (at the rear of the dBDI-2) to an input channel of the mixing console with an XLR cable. (Depending on the situation, this may be a direct connection, or via a stage box, or a studio mic input panel.) Set the controls on your guitar and amplifier in the usual way, and set the Pad switch to either -20dB or 0dB while adjusting the input gain on the mixing console channel. The aim is to ensure that no clipping occurs at the mixing console with the guitar's volume control at maximum and you're playing the loudest passages. You can set the amplifier controls as you want, as they do not affect the signal being sent to the mixing console.

GUITAR, BASS GUITAR...



PEDAL BOARD IN

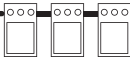

PEDAL BOARD OUT

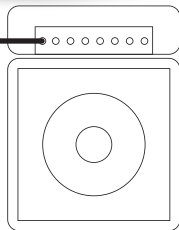
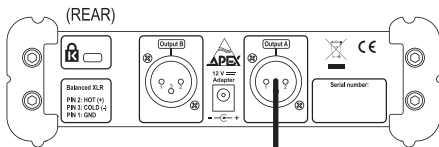
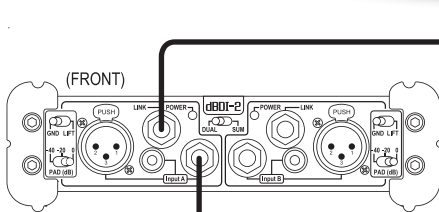

GUITAR AMPLIFIER

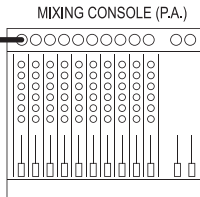

2

Obtaining a recording or FOH feed from a stereo keyboard

Many keyboards have stereo outputs, so you can use the two channels of a single dBDI-2 to interface a keyboard (or sampler, etc.) to a mixing console in a stage or recording situation. Connect the L and R outputs of the keyboard (usually on 1/4" jacks) to the 1/4" jack inputs of the two channels of the DI box. Then connect the two outputs to the mixing console, directly or otherwise, using XLR cables. The most likely setting for the Pad switch in this setup will be -20dB. Foldback for the keyboards player can be derived from the mixing console in a studio situation.

KEYBOARD (or SAMPLER, DRUMPAD, DJ MIXER, PC, CD or MP3 PLAYER...)

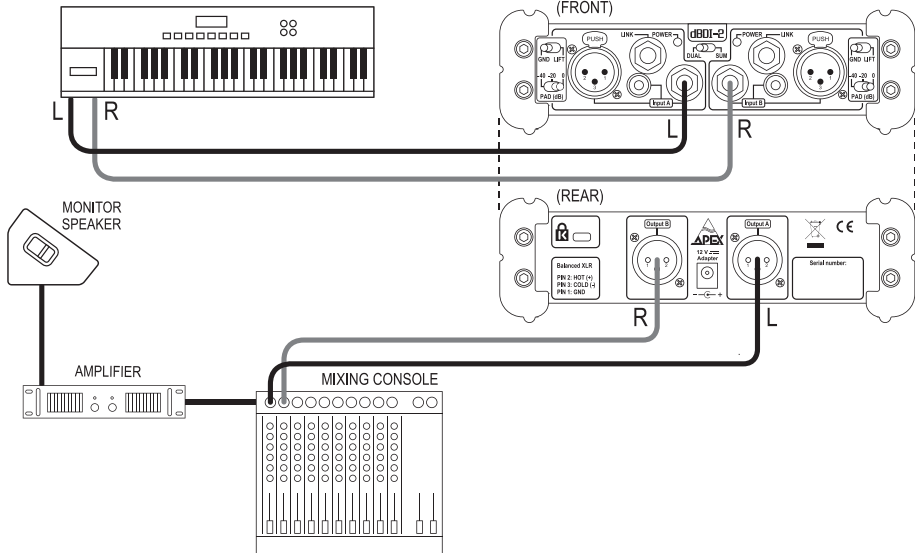

3

Obtaining a recording or FOH feed from the output of a guitar amplifier

Many guitarists wish to retain their “amp sound” during recording or when playing with large PA systems, particularly when using valve/tube amps. The dBDI-2’s ability to be inserted in circuit between the output of the guitar amp and the speaker cabinet (assuming you’re not using a combo amp) lets you do this. Use a normal speaker cable to connect between the amp’s output and the ¼” jack input of one channel, and run another from the LINK output of the same channel to the speaker cabinet.

The rear XLR output of the channel in use goes to the mixing console in the normal way. Always set the Pad switch to -40dB when using this configuration. The volume and tone of the guitar sound sent to the console is now determined by the amplifier settings, and will include amplifier-imparted characteristics such as valve/tube and output transformer saturation.

GUITAR, BASS GUITAR...



AMPLIFIER OUTPUT

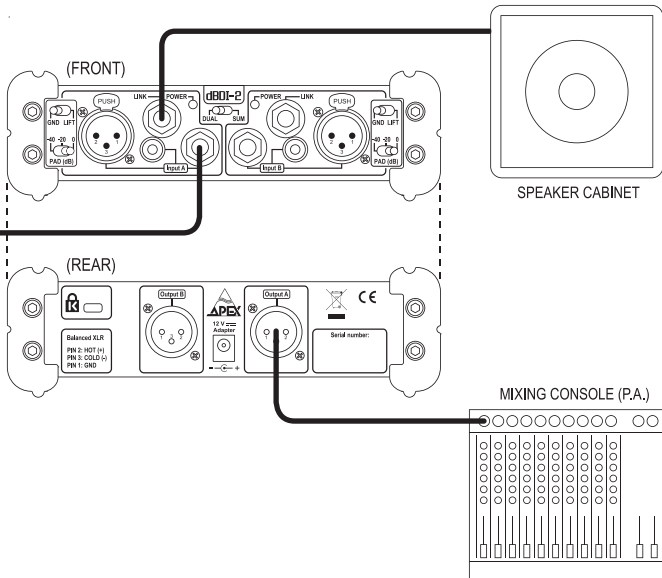
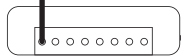

4

Hooking up a laptop to a DJ mixer

Attempting to interface computer sound cards to an audio system often generates hum, buzzes and other extraneous digital noises due to the poor design of computer power supplies. Laptops are particularly bad in this respect. The dBDI-2 can be used to provide electrical isolation between the computer and the audio system, which will resolve all noise problems in most cases. Use a computer audio cable with a 3.5mm 3-pole jack at one end and two phono (RCA) plugs at the other. Plug the jack end into the computer's sound card output (use the "line out" connector rather than a "headphone" output if one is available) and plug the other end into the phono sockets of the dBDI-2's two channels.

If the DJ console has balanced XLR inputs available, use two XLR cables to connect the DI box outputs to these. If only unbalanced inputs on 1/4" jacks (or phonos) are available, either use two XLR-to-1/4" mono jack (or phono) cables, or standard XLR cables with XLR-to-jack (or XLR-to-phono) adapters. In either case, the output of the DI box will become unbalanced, and thus long cable lengths should be avoided. Satisfactory results should be obtainable with the Pad switch set to -20dB.

Note in this application that most DJ consoles do not provide phantom power at any inputs, even if they are equipped with XLRs. Thus it will generally be necessary to power the dBDI-2 from an external AC adapter, as shown.

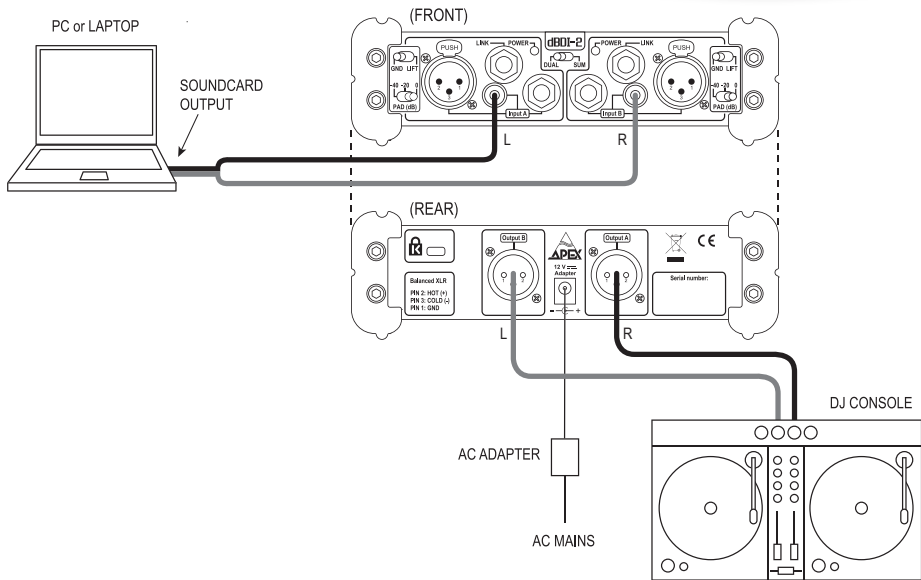

5

Using the dBI-2 as a line-level splitter

This example is an extension of Example 1. The guitarist is using the dBDI-2 to send the (raw) guitar signal to the FOH mixing console as before, but by setting the Dual/Sum switch to Sum, a second output, completely independent of and isolated from the first, is available at Output B, to feed the monitor mixing console.

This configuration can also be used to generate an isolated instrument feed for live recording or broadcast purposes.

When the Dual/Sum switch is set to Sum, it is important to ensure that the position of the ground lift switches on both channels are identical. This ensures a common ground potential between the channels, resulting in improved performance.

GUITAR, BASS GUITAR...

SET DUAL/SUM SWITCH TO SUM

(FRONT)

(REAR)

GUITAR AMPLIFIER

STAGE MONITORS MIXING CONSOLE

FOH MIXING CONSOLE

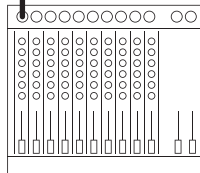
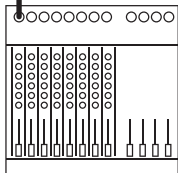
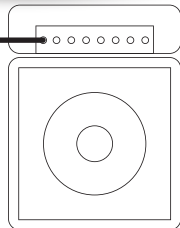
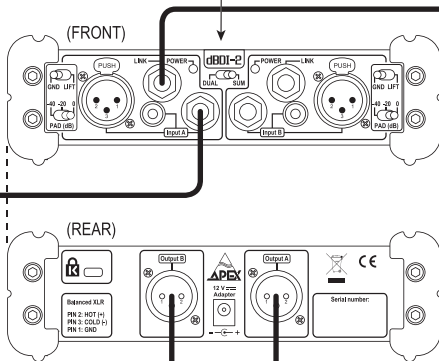

6

Using two dBDI-2s with stereo keyboards to reduce the number of mixer channels required

This example shows a convenient way of reducing the number of channels required at the mixing console from four to two when using two stereo keyboards on stage. The two keyboards are connected to the two dBDI-2s as follows:

Keyboard 1 L	to	dBDI-2 #1 Input A
Keyboard 1 R	to	dBDI-2 #2 Input A
Keyboard 2 L	to	dBDI-2 #1 Input B
Keyboard 2 R	to	dBDI-2 #2 Input B

The stereo output to the mixing console is taken from Output A of dBDI-2 #1 (L) and Output A of dBDI-2 #2 (R). The output levels of the two keyboards should be matched during sound check to avoid the FOH engineer having to adjust his input gains when the player switches from one keyboard to another.

When the Dual/Sum switch is set to Sum, it is important to ensure that the position of the ground lift switches on both channels are identical. This ensures a common ground potential between the channels, resulting in improved performance.

Electrical specifications

Unbalanced input

Connectors:

1/4" TRS jack (Tip = hot, Ring = Sleeve = ground)

3-pin XLR (Pin 2 = hot, Pin 1 = Pin 2 = ground)

RCA (Phono) (Tip = hot, Sleeve = ground)

Parallel output 1/4" TRS

Attenuator:

0 dB

20dB

40 dB

Impedance:

1 M-ohm

>40k-ohm

>40 k-ohm

Max input level:

+9 dBu

+29 dBu

+33 dBu

Transformer balanced output

Connector:

3-pin XLR (Pin 1 = ground, Pin 2 = hot, Pin 3 = cold)

Impedance:

< 50-ohm

Max output level:

+9dBu into 600 ohm load

Audio performance

Frequency response:

20 Hz - 20 kHz, +0/-0.5 dB into >1k5 load

Signal to noise ratio (S/N):

110 dB, ref. 0 dBu, 22 kHz BW, unity gain, unweighted

Total Harmonic Distortion + Noise (THD+N):

less than 0,005%, 0 dBu, 30Hz- 20 kHz, unity gain, 22 kHz BW

Channel separation (Crosstalk):

-75 dB, 20 Hz - 20 kHz, 0 dBu

Phantom power requirements

Voltage:

+48 Vdc

Current drain:

less than 10 mA per channel

External AC adapter requirements

Voltage:

+9Vdc to +12 Vdc

Current drain:

less than 18 mA total

Mechanical specifications

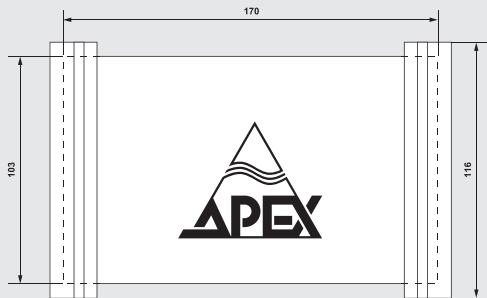

Netto weight: 870 g

Packaging width: 200 mm
depth: 120 mm
height: 60 mm

Shipping weight: 1 kg

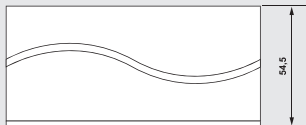
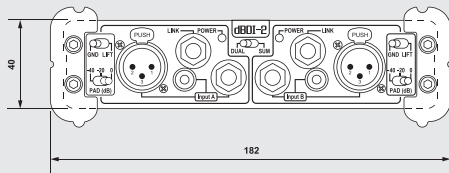

In the interest of product development, Apex reserve the right to modify or improve specifications of this product at any time, without prior notice and without any obligation to change or update equipment already delivered.

Limited warranty

Apex N.V. ("Apex") warrants you, the original purchaser, or any party that purchases the device from you, that its products are free from defects in material and workmanship under normal use for a period of two (2) years from the date of original purchase. The date of purchase is the date which appears on the first invoice or any other proof of purchase provided by an Apex approved dealer.

Subject to the conditions and limitations set forth below, Apex will, at its discretion, either repair or replace any part of its products that prove to be defective, provided that the product is returned with proof of purchase, shipping prepaid, to an authorised Apex approved service facility.

Warranty cover of any repairs will only extend to the end of the original warranty period.

We will be happy to provide you with a list of authorised dealers to whom you can return the defective unit or who will give you a returns note to enable you to send the unit to the factory.

Service turn-around time will be as fast as reasonably possible. If you are not satisfied with the repair, contact Apex.

Exclusions and limitations

This limited warranty covers only repair or replacement for defective products manufactured by Apex. Apex is not liable for, and does not cover under warranty, any loss of data or any costs associated with determining the source of system problems or removing, servicing or installing Apex

products. This warranty excludes 3rd party software, connected equipment or stored data. Apex does not warrant that the operation of the product will be uninterrupted or error-free. In the event of a claim, Apex's sole obligation shall be replacement of the hardware.

This limited warranty does not cover:

- (1) any damage to this product that results from improper installation, accident, abuse, misuse, natural disaster, insufficient or excessive electrical supply, abnormal mechanical or environmental conditions or other external causes;
- (2) any damage caused by operating the product outside the permitted or intended uses described by Apex;
- (3) any damage caused by any unauthorized disassembly, repair, or modification;
- (4) consumable parts, such as batteries;
- (5) any cosmetic damage.

Apex is not liable for consequential damages.

This limited warranty also does not apply to any product on which the original identification information (including serial number) has been altered, obliterated or removed or any product that has not been handled or packaged correctly.

Warranty services will be furnished only if the product is accompanied by a copy of the original retail dealer's invoice.

Warranty claims other than those indicated above are expressly excluded.

www.apex-audio.eu info@apex-audio.eu

Copyright

© 2009 APEX N.V. All rights reserved. This manual may not be reproduced or transmitted, either in part or as a whole, by any means, be they mechanical or electronic, without the express written permission of APEX N.V.



Please recycle